



±50° Dual-Axis Wide-Range Electrolytic Tilt Sensor

Part Number: **0717-4319-99**

Operating Specifications

Operating Range	±50°
Linear Range	±20°
Axes of Measurement	2
Linearity (±50°)	≤5%
Linearity (±20°)	≤1%
Repeatability	±0.1°
Resolution	≤0.003°
Null Offset	≤5°
Cross Axis (Roll) Sensitivity	≤0.025° per degree
Long Term Stability/Drift	≤0.1°
Null Temperature Coefficient	≤0.006° per °C
Scale Temperature Coefficient	0.1% per °C
Operating Temperature	-40 °C to 85 °C
Storage Temperature	-55 °C to 125 °C
Null Impedance	50 kΩ
Time Constant (63.2% of final output)	≤100 ms
Materials	Contains magnetic metals
Maximum Current at Null	0.2 mA (continuous)

Physical Characteristics

Height (including leads)	18.8 mm (0.740")
Diameter (cap)	8.26 mm (0.325")
Diameter (flange)	9.10 mm (0.360")
Lead Spacing (center to center)	2.54 mm (0.100")
Lead Diameter	0.48 mm (0.019")
Lead Length	5.08 mm (0.200")
Weight	1.5 g

Ordering Information

Part Number	Description
0717-4319-99	Tilt Sensor, ±50°, 2 Axis

Compatible With

Part Number	Description
1-6200-005	Signal Conditioner, SPI
1-6200-006	Signal Conditioner, RS-232
1-6200-007	Signal Conditioner, Analog/PWM
1-6200-008	Signal Conditioner, RS-485
1-6200-012	Signal Conditioner, Analog/RS-232

Related Products

Part Number	Description
0717-4315-99	Tilt Sensor, ±60°, 2 Axis
0717-4318-99	Tilt Sensor, ±60°, 2 Axis
0729-1751-99	Inclinometer, ±60°, 2 Axis, SPI
0729-1752-99	Inclinometer, ±60°, 2 Axis, RS-232
0729-1753-99	Inclinometer, ±60°, 2 Axis, Analog and PWM
0729-1754-99	Inclinometer, ±60°, 2 Axis, RS-485
0729-1755-99	Inclinometer, ±60°, 2 Axis, Analog
0729-1759-99	Inclinometer, ±60°, 2 Axis, RS-232
0729-1760-99	Inclinometer, ±60°, 2 Axis, RS-485

Description

The **0717-4319-99** dual-axis, wide-range electrolytic tilt sensor has a robust, all-metal construction providing durability while maintaining superior tolerances and sensor to sensor performance. It is an economical tilt sensor ideal for a versatile range of applications in many markets.

This is a passive electrolytic tilt sensor that requires signal conditioning electronics to provide an output. For a list of compatible signal conditioners, see the Compatible With section.

Key Features and Benefits

- ±0.1° repeatability, ≤0.003° resolution, very high accuracy
- ≤0.1° long term drift with an extremely long life
- Minimal drift compared to MEMS devices
- -40 °C to 85 °C operating temperature for industrial applications
- Live text and video chat technical support

Applications

- [Recreational vehicle \(RV\) leveling systems](#)
- [Construction Tools](#)
- [Construction Vehicles](#)
- [Agricultural machinery and equipment](#)

View the full list at www.frederickscompany.com/markets.

Linear and Operating Range Behavior

Linear Range

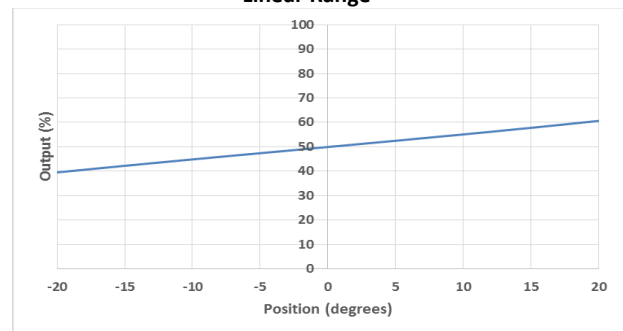

Operating Range

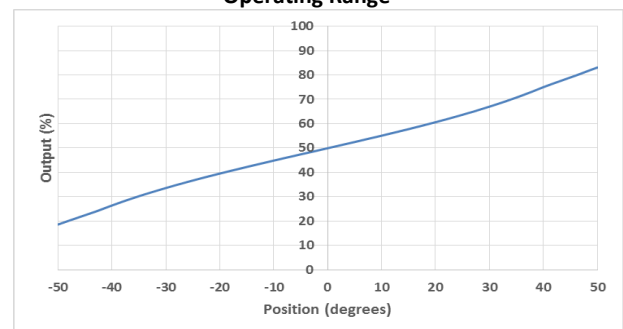

Click to Buy Online from Fredericks Now!



±50° Dual-Axis Wide-Range Electrolytic Tilt Sensor
Part Number: 0717-4319-99

Functional Diagram

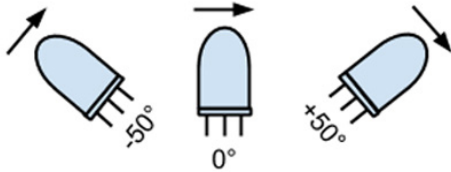

Dimensional Drawings

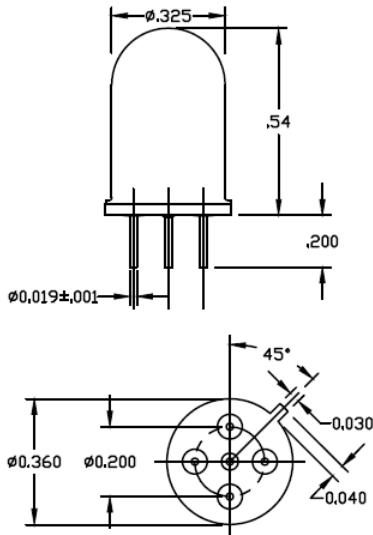

Test Circuit

All data was acquired with a Fredericks Company Dual Axis 6200 Series Signal Conditioner in single axis mode at 20 °C. A general schematic of our signal conditioners is provided below. Further information on sensor excitation and excitation circuitry is provided on [The Fredericks Company website](#) and in the [application note AN1000](#).

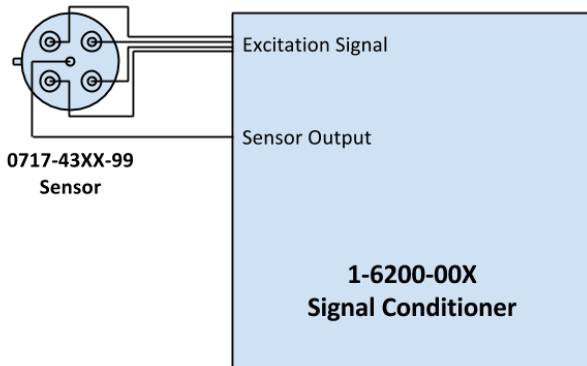

Certifications and Ratings

- RoHS Compliant

Notes

When using an excitation circuit not designed by The Fredericks Company, ensure that no direct current passes through the sensor. Direct current will lead to sensor damage, output drift, and general instability. For a description of hardware and software design for this sensor, see [application note AN1000](#).

The **0717-4319-99** and all Fredericks tilt sensors must be mounted horizontally (parallel to the surface of the earth and perpendicular to the force of gravity). For best performance, isolate the sensor from vibrations when mounting it.

Additional Documentation

- [AN1000 Electrolytic Tilt Sensor Excitation](#)
- [AN1001 Temperature Compensation of Electrolytic Tilt Sensors](#)
- [AN1005 Converting Tilt Angle to Degrees](#)

Company Information

Specialty Manufacturing Services That Promise Precision - Since 1935, The Fredericks Company has been a global provider and U.S. designer and manufacturer of the highest performance tilt and vacuum measurement products on the market, with manufacturing processes that ensure the reliability of our products.

Tilt Measurement Products and Sensors That Set Standards - Fredericks' comprehensive tilt measurement product portfolio offers [electrolytic tilt sensors](#), [inclinometers](#), and [tilt switches](#). Engineered to outperform competing technology, our tilt sensors are accurate and repeatable with excellent resolution. Our tilt measurement products have no planned obsolescence and serve industries ranging from [construction](#) and [RV leveling](#) to aerospace applications and everything in between.

A Partnership That Prioritizes Uptime, Lead Time, and Service - Fredericks guarantees customer satisfaction and our “not too big, not too small” operation is what enables us to offer a true partnership experience. Our dedicated representatives and engineers offer exceptionally responsive service and the fastest lead times in the industry, knowing that uptime is the key to your success. With anytime access to our leadership team and solutions that enhance your products, you will feel the Fredericks difference.

Contact Us

The Fredericks Company
 2400 Philmont Avenue
 Huntingdon Valley, PA 19006
 tel: +1 215 947 2500
 fax: +1 215 947 7464
 email: sales@frederickscompany.com
 web: www.frederickscompany.com

Disclaimer: Specifications subject to change without notice. The Fredericks Company assumes no responsibility for inaccuracies in product specifications or any liability arising from product use.
 © 2022 The Fredericks Company